

Guide for judging condition of relevant piston-running components

LINERS, PISTONS AND PISTON RINGS
Version 5.0 April 2021

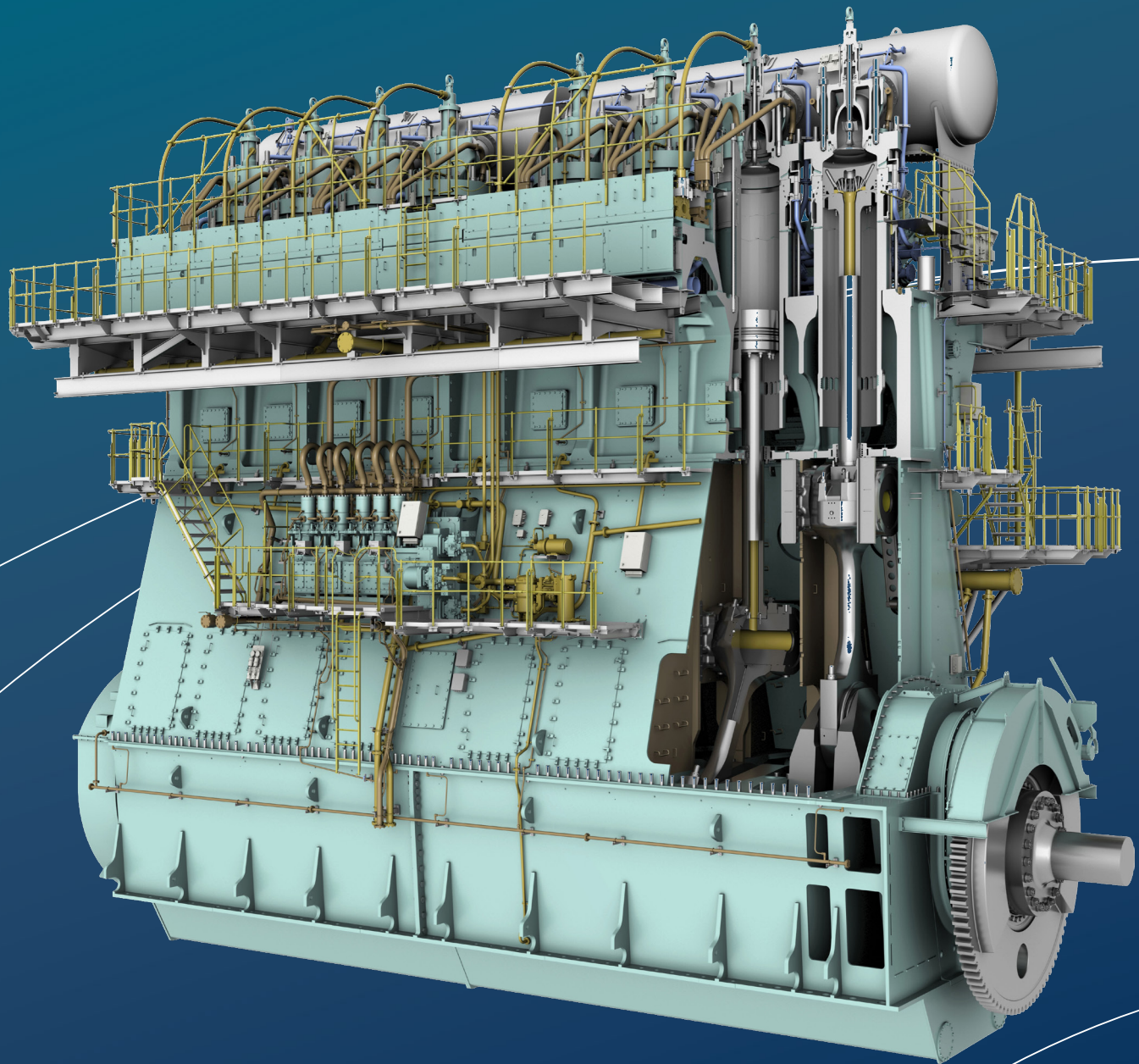

WIN GD

Table of contents

1 Purpose of this booklet.....	3
2 Requirements to extend piston TBO	3
3 Way of working for piston underside inspection	4
4 Tools and equipment.....	5
5 Wear modes	5
5.1 Piston ring.....	5
5.2 Typical liner wear patterns	6
6 Condition assessment for piston rings and cylinder liner	7
6.1 Normal and acceptable conditions	7
6.1.1 Piston rings	7
6.1.2 Liner	9
6.2 To be monitored	10
6.2.1 Piston rings	10
6.2.2 Liner	12
6.3 Action required.....	14
6.3.1 Piston rings	14
6.3.2 Liner	18
6.4 How to identify a scuffed liner	20
6.5 Possible actions for locally scuffed liners (temporary measures)	21
6.6 Pre-requisites for a cylinder liner before it can be re-honed	22
6.7 Requirements for a cylinder liner after honing	22
7 Piston crown condition	23
8 Sample pictures for a visual inspection report.....	24
9 Template example for regular measurements and visual inspection report	28
10 Selection of the cylinder oil	29
11 Cylinder oil sampling.....	30
12 Piston underside drain oil analysis interpretation	31
13 Feed rate optimization.....	32
14 Running-in of new components.....	33
15 List of piston-running relevant WinGD technical documents	33
16 Notes	34
17 Contacts	35

1 Purpose of this booklet

This booklet shall serve as a guide for judging the condition of relevant components (liners, pistons and piston rings) for the condition-based maintenance during piston and liner overhauls of engines with latest piston-running standard with full CC (chromium ceramic) piston ring packages or CC top ring and lower RC (running-in coating) rings for smaller bores.

Actual wear rates strongly depend on operational factors, such as fuel oil in use, engine load profile, ambient conditions etc.

Engines operated under controlled conditions (e.g. piston underside drain oil analysis and visual inspection), piston overhauls can be extended, and piston TBO beyond 30'000 hours is achievable.

By visual inspections, critical conditions of liners and piston rings can be detected at an early stage and if appropriate countermeasures are taken, sudden severe wear (scuffing), losing liners and piston rings, can be avoided and the reliability enhanced.

Other measures such as analysis of piston underside drain or scrape oil sample will provide further information to monitor the liner and piston ring conditions.

We recommend carrying out visual piston underside inspections every four to eight weeks.

Inspections with measurements of piston ring coating thickness, ring groove clearance and loss of material on top of piston should be carried out two to three times per year.

By no means can guides such as these cover all possible conditions and in case of questions we suggest contacting Winterthur Gas & Diesel Ltd. For contact details, see chapter 16.

© Copyright, 2021 Winterthur Gas & Diesel Ltd.
Research & Development

Matthias Berchtold
Roger Mäder

2 Requirements to extend piston TBO

The TBO can be extended based on the following requirements:

- Visual conditions as shown in chapter 6.1
- Remaining CC coating for top piston rings greater than 50 µm and for lower CC coated rings greater than 20 µm. (Below those limits, piston ring replacement should be planned)
- Ring groove clearances within acceptable limit see maintenance manual
- Loss of material on top of piston within limits
- No water or oil leakages from liners, valves or pistons inside of combustion space and piston underside

As guidance the following specific guide wear rates can be considered:

- Liner specific wear rates (diametrical) from 0.03 to 0.10 mm/1000 hours are considered as acceptable
- Top ring specific wear rates (radial) of ~0.01 mm/1000 hours are to be considered as acceptable
- Ring groove specific wear rates of ~0.01 mm/1000 hours are to be considered as acceptable

3 Way of working for piston underside inspection

Before entering the piston underside make sure that the necessary safety precautions are met:

- Inspection to be done with another person
 - Open air spring drain valve 35.36HA to open the exhaust valves during the inspection for air circulation and to check for oil leakage through valve spindle
 - Engage turning gear and make sure that indicator cocks are open, if not done already
 - Starting-air shut off valve 2.03 / 30-4325_E0_1 to be closed and starting air pipe drain valve 2.27 / 30-8605_E0_6 & 30-8605_E0_7 to be opened
 - Protect yourself with adequate equipment such as oil resistant gloves and protecting overalls. Do not enter piston underside without protection equipment. Fuel oil residues in piston underside may be harmful to the skin!
 - Install adequate air blowers for ventilation of piston underside and to provide fresh air during the inspection
 - After inspection, before closing inspection doors make sure that nothing is left inside
 - For DF engines, specific safety precautions can be found under the following link: www.wingd.com/media/1998/gas-safety-concept_wingd-2s.pdf
- Before entering piston underside for inspection, review previous reports and check previous liner and piston measurement sheets for reference.
 - For the inspection, the jacket cooling water system should run to detect possible water leakages due to leaking O-rings or cracked parts. Lowering of the cylinder cooling water temperature may reduce the temperature in the piston underside.
 - Keep also the main lubricating oil pumps running, avoiding dry turning of bearings and to check for possible oil leakage from pistons and valve spindles.
 - To get a clear picture of the piston ring condition, it is recommended that all piston rings are checked around their full circumference, if space in piston underside permits it. If space is limited use a mirror for visual inspection.
- Scorings / initial scuffing marks are often first found on the lower rings. Hence all piston rings are always to be checked visually.
 - Designation of piston rings is normally A for the top ring B for the 2nd, C and D for third and fourth ring
 - Use expression as per OM for designating positions e.g. EXH (exhaust side), DE (driving end), FP (fuel pump side) and FE (free end)
 - For correct piston ring designations please refer to engine manual and markings on piston rings
 - Mark the unit number and piston rings properly with paint marker
 - Be aware of the condition in which the engine was operated before the inspection:
 - Extended period of low load
 - Sulphur content of fuel oil in use
 - A long period of manoeuvring which would result in a high lubricating oil consumption
 - If the engine was changed over to MDO
 - Type and grade of cylinder oil in use (Base number)

Check cylinder block and receiver structure, water separators and non-return flaps for abnormalities.

4 Tools and equipment

For visual inspections:

- Flash or head light
- Mirror
- Digital camera
- Paint marker
- Protective equipment as described above
- Rags
- Turning gear remote control

For inspection with measurements on piston rings, ring grooves and piston crown, additional equipment is required:

- Coating thickness measuring device (Fischer Dualscope MP0, Order code number: 94356) Make sure, that the device is properly calibrated on piston ring base material (use upper flank of a spare top ring) according to manual.
- Feeler gauge
- Recording templates
- Template 94366a to check loss of material on piston crown

5 Wear modes

5.1 Piston ring

While defining the wear mode that has taken place, one can refer to the following table summarising the typical wear pattern. The proposed flow diagram depicts some typical wear scenarios that may have taken place.

Wear type	Wear characteristic pattern
Adhesion	<ul style="list-style-type: none">• Material transfer from the softer to the harder material. Brownish deposits on piston rings• Plastic deformation• Micro marks with irregular border (scores)
2 body abrasion	<ul style="list-style-type: none">• Micro marks with regular border (scratch)
3 body abrasion	<ul style="list-style-type: none">• Random orientation grooves• Micro marks with regular border (scratch)• Indents• Plastic deformation
Corrosion	<ul style="list-style-type: none">• Coloured surface film• Non uniform aspect• Pits aspect on the liner
Delamination fatigue	<ul style="list-style-type: none">• Fracture parallel to the surface• Pits, flakes

5.2 Typical liner wear patterns

The wear pattern on the liner itself also gives some indication as to the nature of the cylinder liner wear and may differ from engine type to engine type.

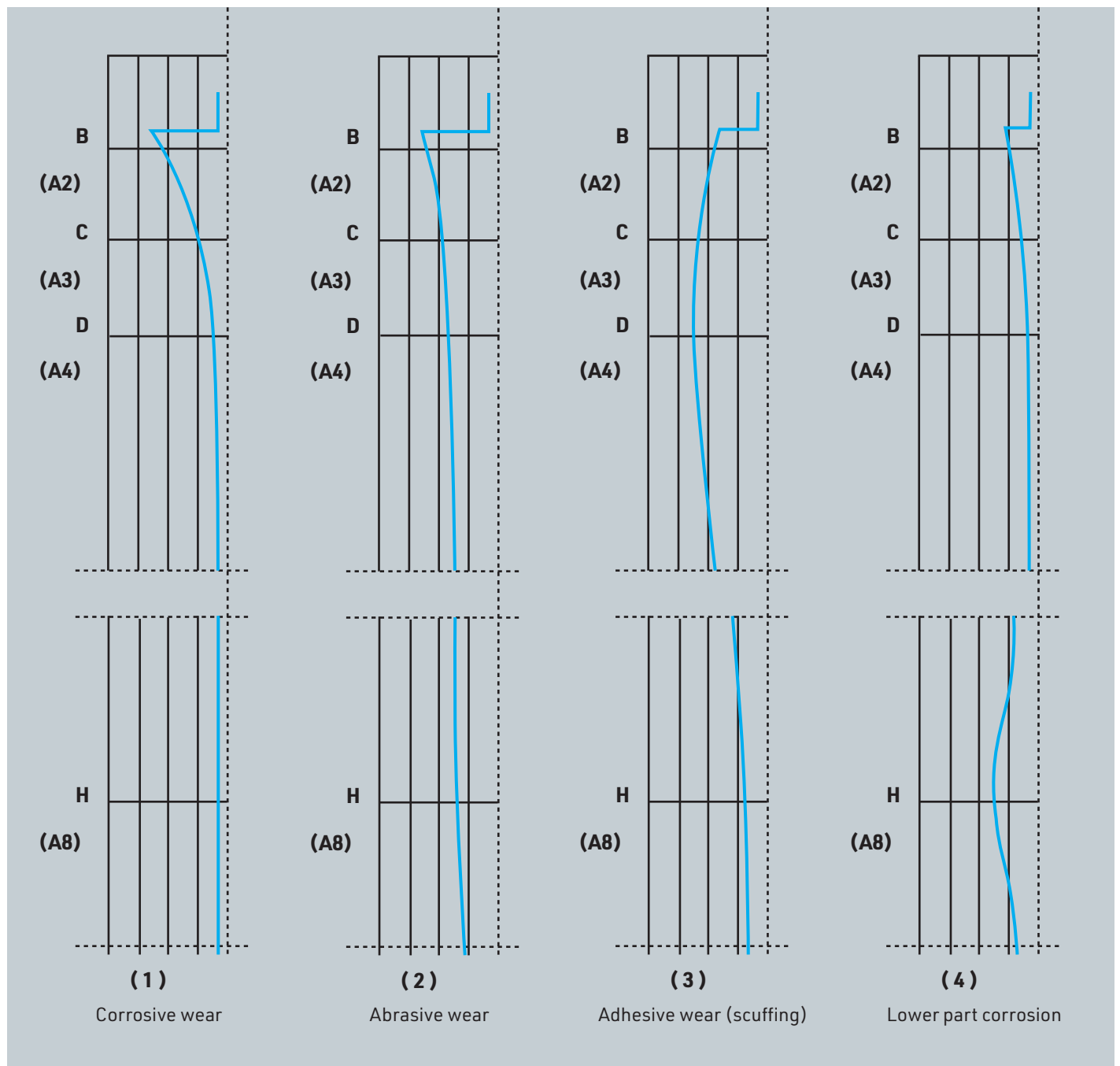

The actual wear on cylinder liners and piston rings is not simply a linear function, but depends on operating conditions and can be a combination of above wear modes.

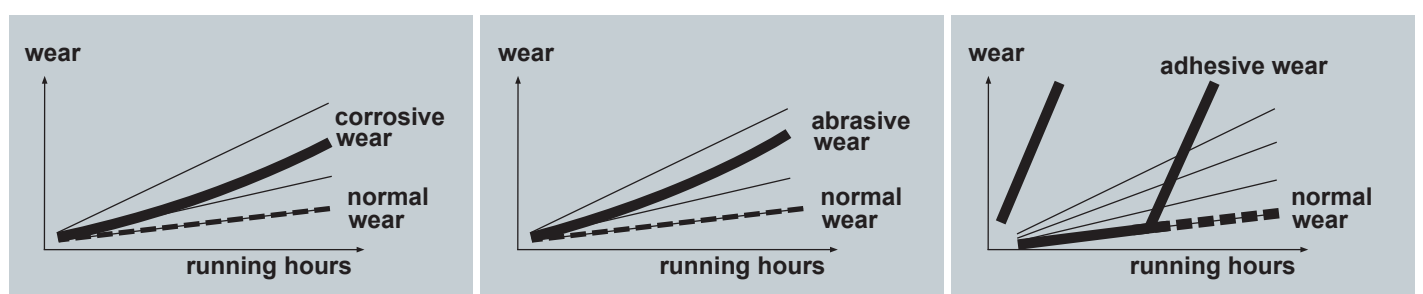

6 Condition assessment for piston rings and cylinder liner

6.1 Normal and acceptable conditions

6.1.1 Piston rings

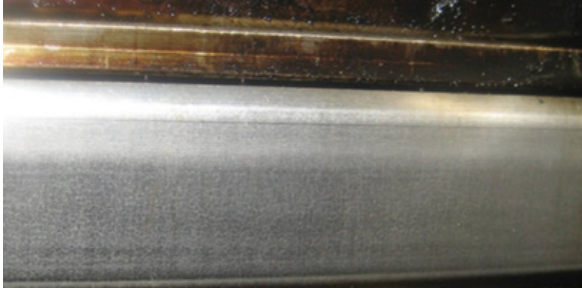

Ring type: SCP1CC20, A ring
Condition: Normal condition, secondary crack network slightly visible
Acceptance: Normal
Action: No action required

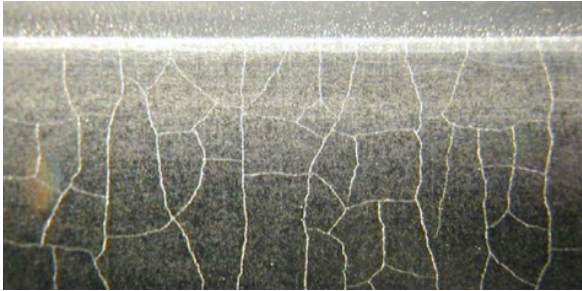

Ring type: SCP1CC20, A ring
Condition: Normal condition, regular secondary crack network
Acceptance: Normal
Action: No action required



Ring type: SCP1CC20, A ring
Condition: Abrasion (3 body abrasion) can be caused by catalyst fines in fuel oil, or foreign hard particles (e.g. sand in intake air).
Acceptance: Acceptable
Action: See technical bulletin RT-140



Ring type: SCP1RC16, B ring
Condition: RC running-in coating in spotless condition
Acceptance: Acceptable
Action: No action required

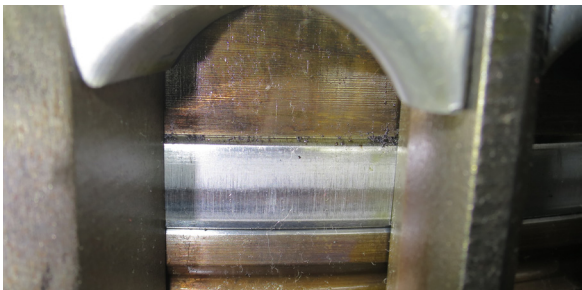

Ring type: GTP1CC17
Condition: Abrasive scratches on piston ring running surface by foreign particles
Acceptance: Acceptable
Action: No action required



Ring type: GTP1CC24
Condition: Erosion at GT ring gap by combustion gases
Acceptance: Normal
Action: No action required

6.1 Normal and acceptable conditions

6.1.1 Piston rings

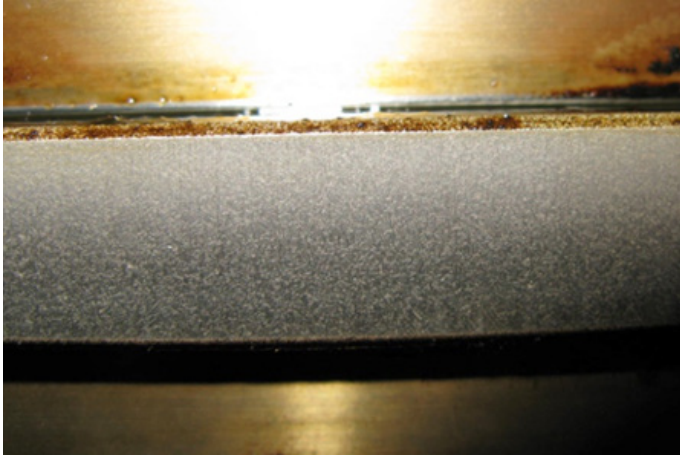

Ring type: SCP1RC16, C ring
Condition: RC running-in coating gone, ring running on base material, spotless condition
Acceptance: Normal
Action: No action required

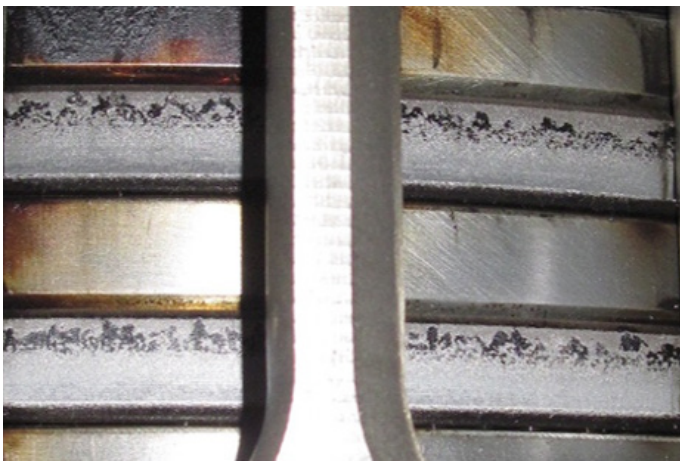

Ring type: SCP1RC15, B and C ring
Condition: Some RC running-in layer spalling
Acceptance: Acceptable
Action: No action required

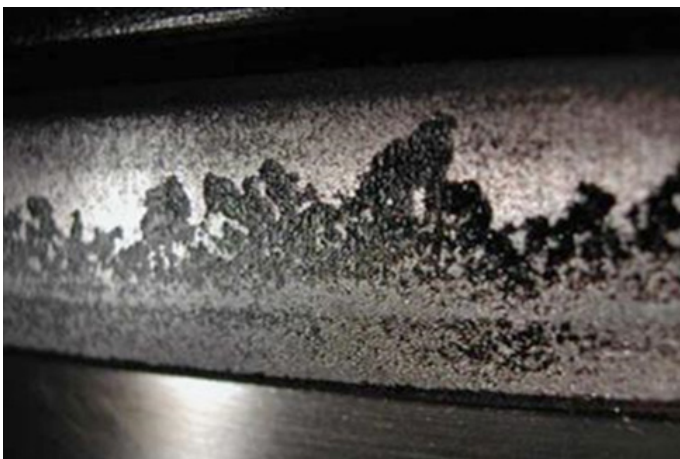

Ring type: SCP1RC15, B ring
Condition: Some RC running-in layer spalling
Acceptance: Acceptable
Action: No action required



Ring type: GTP1CF24, A ring
Condition: Bottom face Cr coating fretting
Acceptance: Acceptable
Action: No action required

6.1 Normal and acceptable conditions

6.1.2 Liner

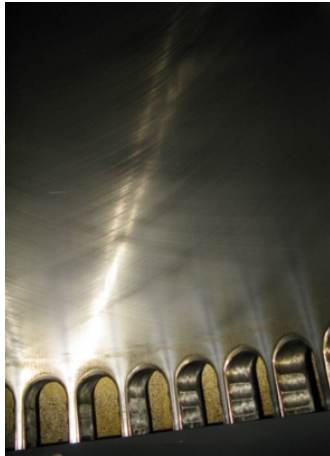

Condition: Spotless condition of liner, honing marks clearly visible
Acceptance: Normal
Action: No action required

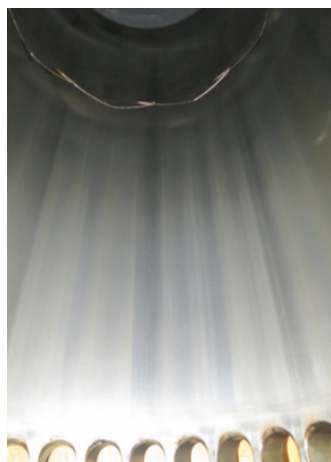

Condition: Good liner condition, smooth and homogenous liner appearance, honing marks not visible anymore
Acceptance: Normal
Action: No action required

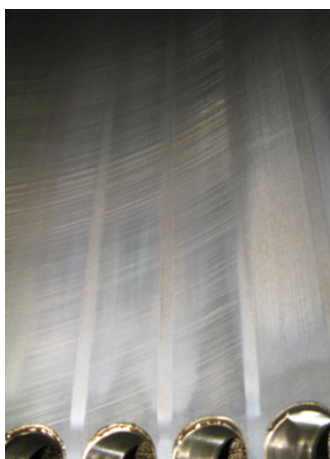

Condition: Cylinder liner with minor cold corrosion (milky spots)
Acceptance: Normal
Action: No action required



Condition: Single scratches on liner surface
Acceptance: Normal
Action: No action required

6.2 To be monitored

6.2.1 Piston rings

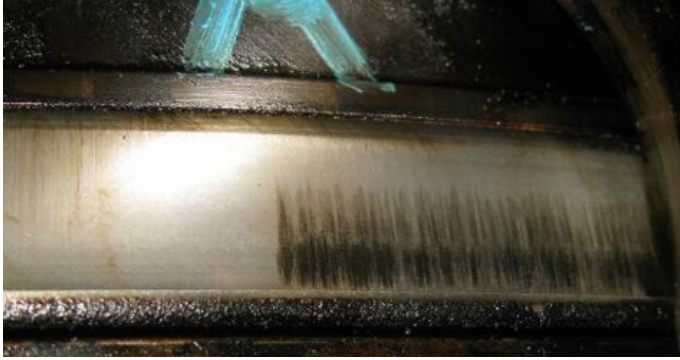

Ring type: SCP1CC20, A ring
Condition: Hard contact marks
Acceptance: To be monitored. Piston ring may recover
Action: Check entire ring surface. Temporary increase of set feed rate by 0.2 g/kWh and if possible reduce injection correction factor in flexView or UNIC to 80% or install spacer in fuel pump for RTA engines. Consider exhaust gas deviation alarm.

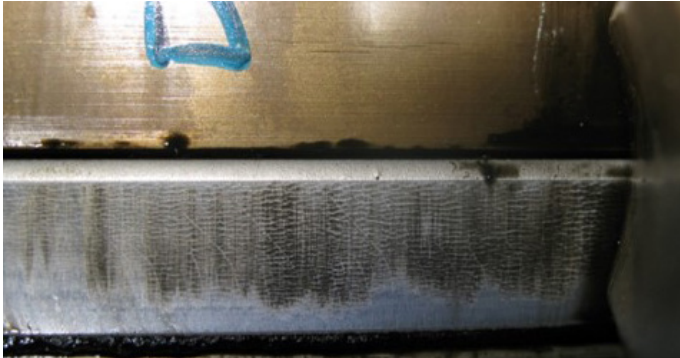

Ring type: SCP2CC20, D ring
Condition: Hard contact marks
Acceptance: To be monitored. Piston ring may recover
Action: Check entire ring surface. Temporary increase of set feed rate by 0.2 g/kWh and if possible reduce injection correction factor in flexView or UNIC to 80% or install spacer in fuel pump for RTA engines. Consider exhaust gas deviation alarm.

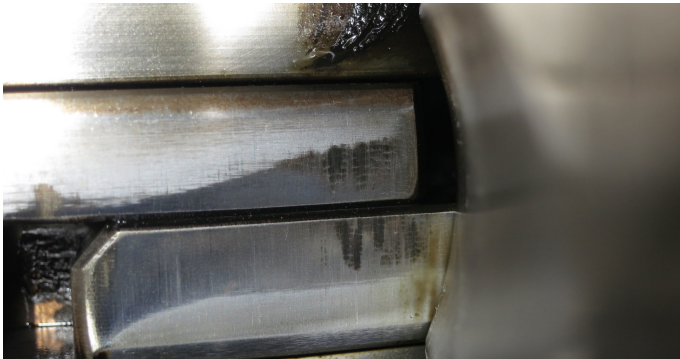

Ring type: GTP1CC22, A ring
Condition: Hard contact marks caused by high contact pressure
Acceptance: To be monitored.
Action: Dressing-up on hard contact spots by hand with 80 grain size emery paper



Ring type: SCP1RC20, B ring
Condition: Hard contact marks, RC coating gone, ring running on base material
Acceptance: To be monitored. Piston ring may recover
Action: Check entire ring surface. Temporary increase of set feed rate by 0.2 g/kWh and if possible reduce injection correction factor in flexView or UNIC to 80% or install spacer in fuel pump for RTA engines. Consider exhaust gas deviation alarm.



Ring type: SCP1CC20, B ring
Condition: Scoring marks
Acceptance: To be monitored. Piston rings may recover
Action: Check entire ring surface. Temporary increase of set feed rate by 0.2 g/kWh and if possible reduce injection correction factor in flexView or UNIC to 80% or install spacer in fuel pump for RTA engines. Consider exhaust gas deviation alarm.

6.2 To be monitored

6.2.1 Piston rings

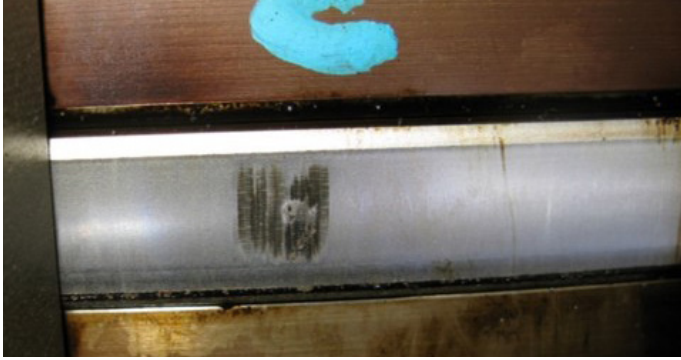

Ring type: SCP2CC20, C ring
Condition: Hard contact marks, scoring marks and initial coating spalling
Acceptance: To be monitored. Piston rings may recover
Action: Check entire ring surface. Temporary increase of set feed rate by 0.2 g/kWh and if possible reduce injection correction factor in flexView or UNIC to 80% or install spacer in fuel pump for RTA engines. Consider exhaust gas deviation alarm. Dressing-up on hard contact spots by hand with 80 grain size emery paper.



Ring type: SCP1CC20, A ring
Condition: Cracked CC coating and spalling
Acceptance: To be monitored. Limited size of spalling
Action: Check entire ring surface. In case spalling is less than 20 mm in length and less than half of the ring height the condition is still acceptable

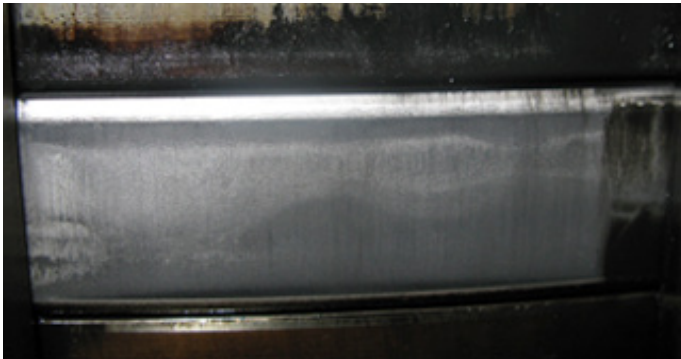

Ring type: GTP1CC24, A ring
Condition: Corrosive attack of CC coating
Acceptance: To be monitored. Corrosion may result in high wear on ring and liner
Action: Check correct cylinder oil feed rate setting. Check residual base number (BN) in piston underside drain oil.



Ring type: SCP1CC20, A ring
Condition: Ring with severe corrosion spots
Acceptance: To be monitored. Corrosion may result in high wear on ring and liner
Action: Check correct cylinder oil feed rate setting. Check residual BN in piston underside drain oil. Check remaining CC coating thickness.

6.2 To be monitored

6.2.2 Liner



- Condition:** Cylinder liner with quite some cold corrosion and some black lacquer
Acceptance: To be monitored
Action: Check correct cylinder oil feed rate setting.
Check residual BN in piston underside drain oil.

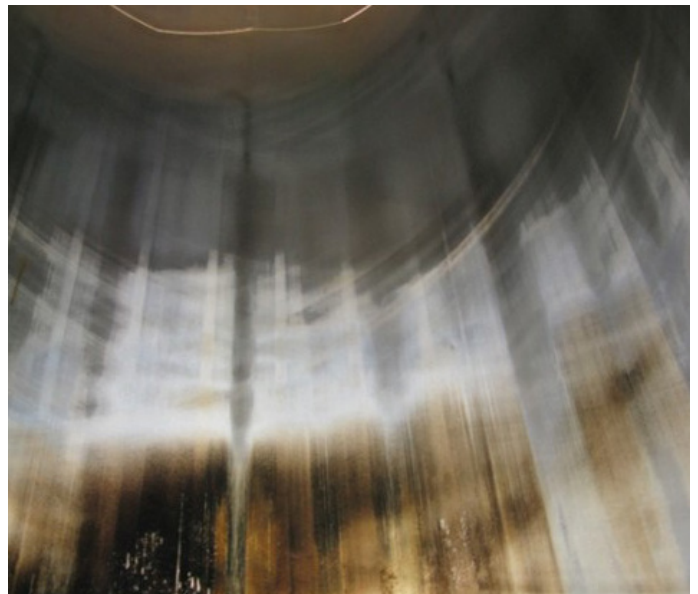

- Condition:** Cylinder liner with black lacquer and cold corrosion
Acceptance: To be monitored
Action: Check correct cylinder oil feed rate setting.
Check residual BN in piston underside drain oil.

The formation and extent of this lacquer formation depends mainly on engine load, sulphur content in fuel oils (~2.7% or higher), set cylinder oil feed rate and air humidity.

6.2 To be monitored

6.2.2 Liner

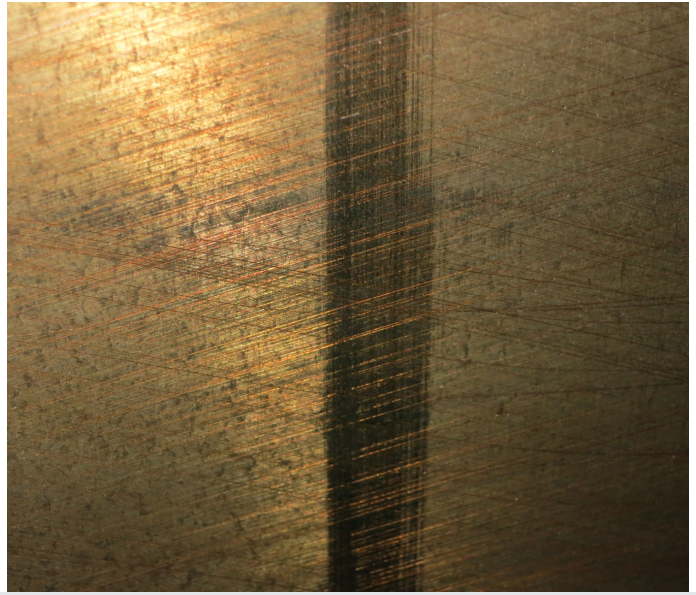
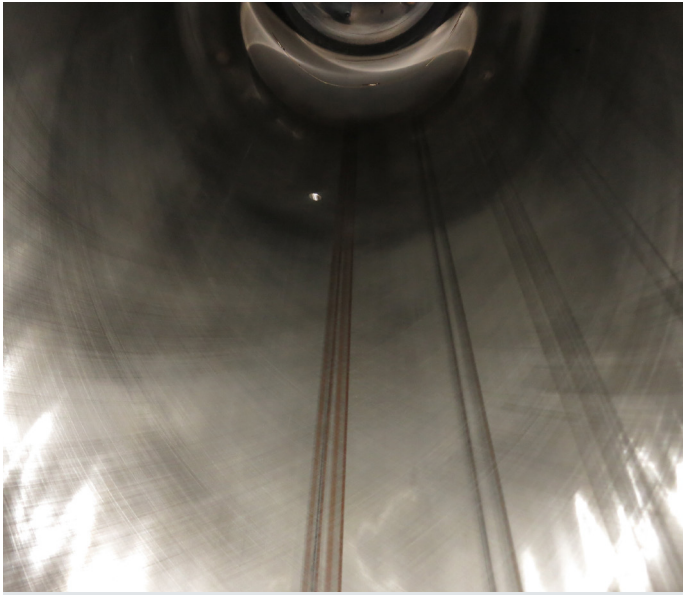

Condition: Hard contact marks on cylinder liner
Acceptance: To be monitored
Action: Piston rings have to be checked all around

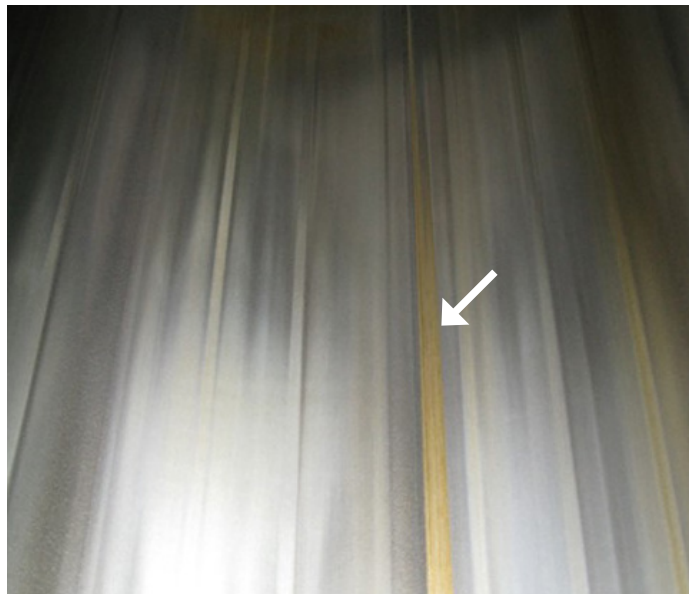
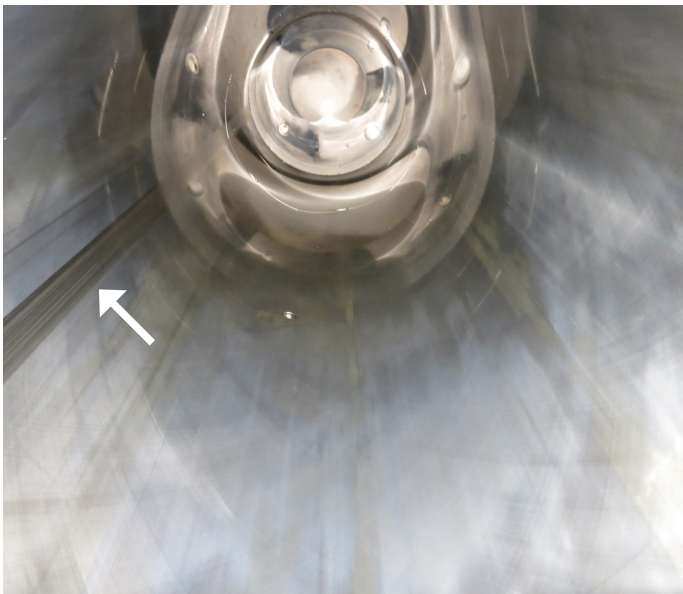

Condition: Single scoring marks on cylinder liner
Acceptance: To be monitored, piston rings have to be checked all around
Action: In case the liner scoring develops further, the unit should be overhauled at the next opportunity and local scoring is to be dressed up

6.3 Action required

6.3.1 Piston rings



Ring type: GTP1CC20, A-ring
Condition: Local scoring / scuffing of ring gap ends
Acceptance: Critical, to be monitored very closely.
Action: Local dressing up of ring end gaps with emery cloth (80 grain size) through scavenging air ports. If condition deteriorates, then piston ring to be replaced and scorings on liner to be dressed up



Ring type: SCP1CC20
Condition: Active scuffing, CC coating destroyed, active scuffing
Acceptance: Critical condition
Action: Unit to be overhauled. Temporary increase of set cylinder oil feed rate by ~0.2 g/kWh and reduce injection correction factor in flexView or UNIC to 80% or install spacer in fuel pump for RTA engines until unit is overhauled. Consider exhaust gas deviation alarm. If ships schedule permits it, switch off the unit, till unit is overhauled.

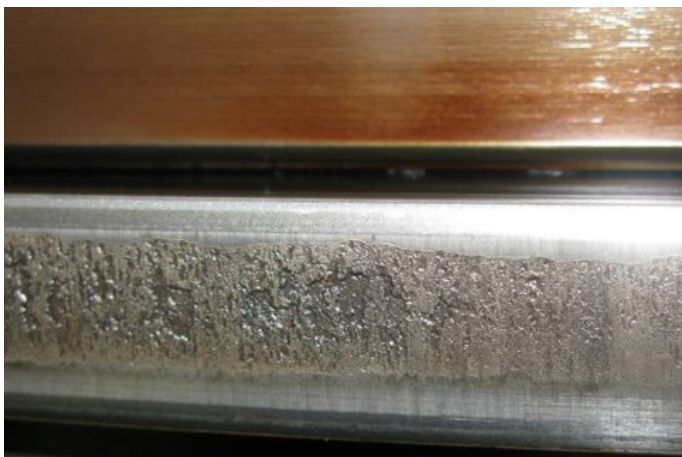

Ring type: SCP1CC20, C ring
Condition: Scuffed, CC coating destroyed and cohesive spalling, active scuffing
Acceptance: Critical condition
Action: Unit to be overhauled. Temporary increase of set cylinder oil feed rate by ~0.2 g/kWh and reduce injection correction factor in flexView or UNIC to 80% or install spacer in fuel pump for RTA engines until unit is overhauled. Consider exhaust gas deviation alarm. If ships schedule permits it, switch off the unit, till unit is overhauled.



Ring type: SCP2CC20, C ring
Condition: Scuffed with some CC remaining active scuffing
Acceptance: Critical condition
Action: Unit to be overhauled. Temporary increase of set cylinder oil feed rate by ~0.2 g/kWh and reduce injection correction factor in flexView or UNIC to 80% or install spacer in fuel pump for RTA engines until unit is overhauled. Consider exhaust gas deviation alarm. If ships schedule permits it, switch off the unit, till unit is overhauled.

6.3 Action required

6.3.1 Piston rings



Ring type: GTP1CF24, A ring
Condition: Locally scuffed, CC coating destroyed and spalling, scuffing not active
Acceptance: Critical condition
Action: Unit to be overhauled. Temporary increase of set cylinder oil feed rate by ~0.2 g/kWh and reduce injection correction factor in flexView or UNIC to 80% or install spacer in fuel pump for RTA engines until unit is overhauled. Consider exhaust gas deviation alarm

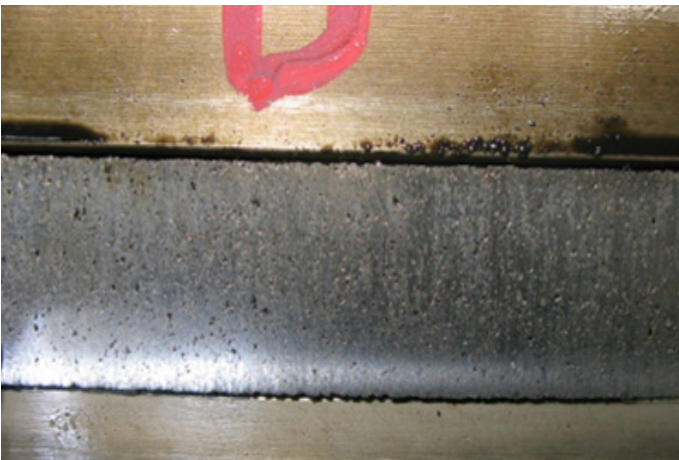

Ring type: SCP2CC20, D ring
Condition: Partly recovered from scuffing, sharp edges with burrs, coating worn down
Acceptance: Critical condition
Action: Unit to be overhauled. Temporary increase of set cylinder oil feed rate by ~0.2 g/kWh and reduce injection correction factor in flexView or UNIC to 80% or install spacer in fuel pump for RTA engines until unit is overhauled. Consider exhaust gas deviation alarm

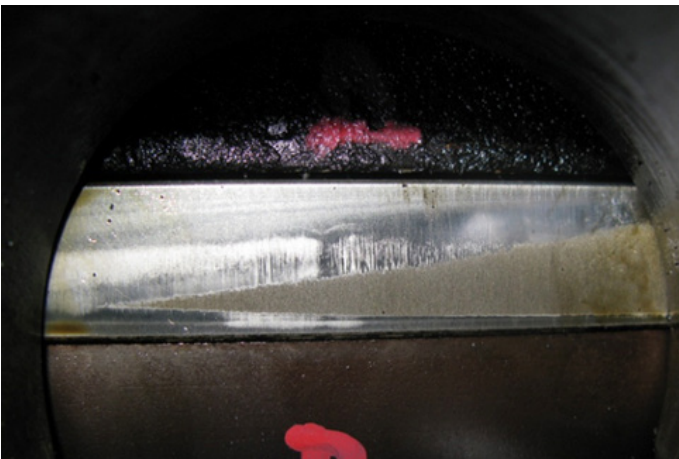

Ring type: SCP1CC20, A ring
Condition: CC coating worn down to base material, corrosion on remaining CC coating
Acceptance: Critical condition, further operation of such rings will result in a greater liner wear and increased risk for scuffing
Action: Unit to be overhauled
Remark: See next picture for possible root cause

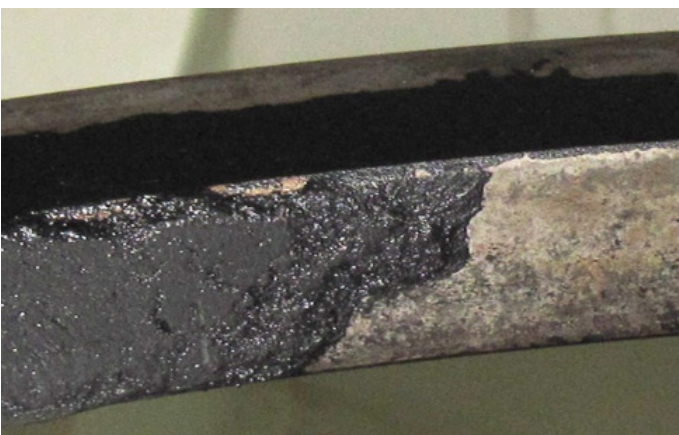

Ring type: GTP1CF24, A ring
Condition: Excessive deposits on ring inner diameter (backside)
Acceptance: Critical condition, may lead to high ring wear and ring can stick
Action: Unit to be overhauled

6.3 Action required

6.3.1 Piston rings



Ring type: SCP1CC20, A ring
Condition: Completely worn CC coating
Acceptance: Critical condition, further operation of such rings will result in a greater liner wear and increased risk for scuffing.
Action: Unit to be overhauled

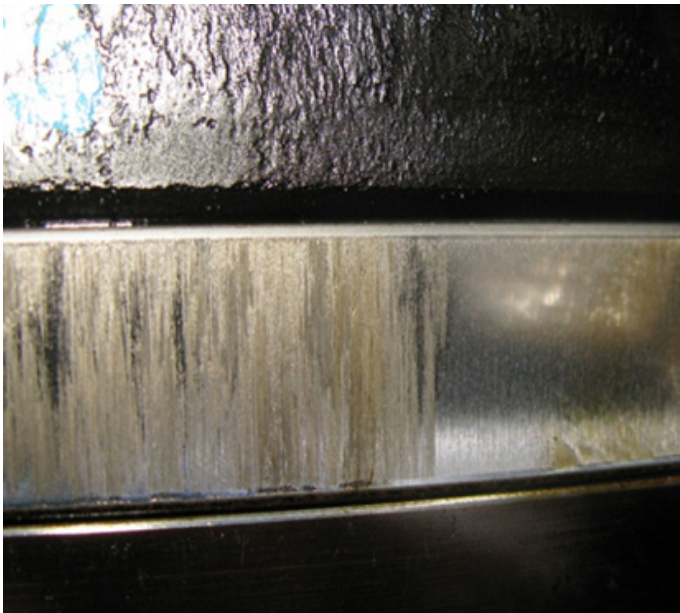

Ring type: SCP1CC20, A ring
Condition: Scoring marks on a worn CC ring
Acceptance: Critical condition
Action: Unit to be overhauled. Temporary increase of set cylinder oil feed rate by ~0.2 g/kWh and reduce injection correction factor in flexView or UNIC to 80% or install spacer in fuel pump for RTA engines until unit is overhauled. Consider exhaust gas deviation alarm.



Ring type: SCP1CC20, A and B ring
Condition: A ring with some corrosion, B ring lost tension, with excessive deposits, cylinder oil feed rate, BN and fuel oil sulphur content not matching
Acceptance: Critical condition
Action: Unit to be overhauled. Check correct cylinder oil feed rate setting. Check residual BN in piston underside drain oil.

6.3 Action required

6.3.1 Piston rings



Ring type: SCP1CC20, A ring
Condition: Ring collapsed, with excessive deposit
Acceptance: Critical condition
Action: Unit to be overhauled. Switch-off unit



Ring type: SCP1CC20, A ring
Condition: Ring broken
Acceptance: Critical condition
Action: Unit to be overhauled. Switch-off unit



Ring type: SCP1CC16, A ring
Condition: A ring with excessive spalling across full ring height
Acceptance: Critical condition
Action: Unit to be overhauled. Temporary increase of set cylinder oil feed rate by ~0.2 g/kWh and reduce injection correction factor in flexView or UNIC to 80% or install spacer in fuel pump for RTA engines until unit is overhauled. Consider exhaust gas deviation alarm



Ring type: GTP1CF24, A ring
Condition: Bottom face Cr coating spalling
Acceptance: Critical condition
Action: Piston ring to be replaced

6.3 Action required

6.3.2 Liner



Condition: Cylinder liner with scoring marks
Acceptance: Critical condition
Action: Depending on piston ring condition unit should be overhauled and liner re-honed. If piston rings are in spotless condition, the unit can be kept in operation

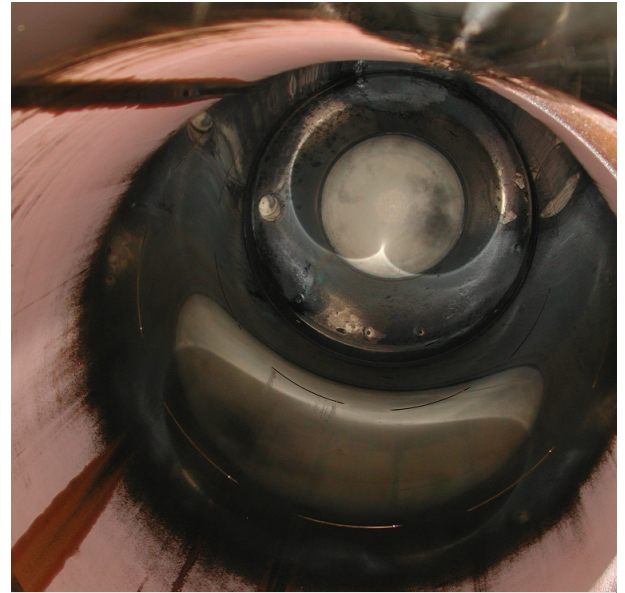
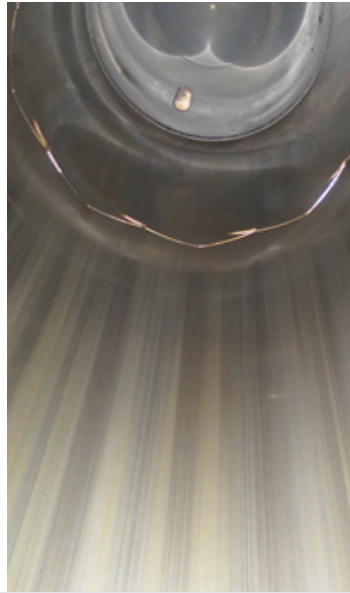

Condition: Water ingress caused rusty liner surface. Only applicable on engines with quills through water guide jacket
Acceptance: Critical condition
Action: Lubricating quills to be checked and overhauled. Check cylinder cover and liner for cracks.



Condition: Liner with local scoring and scuffing marks
Acceptance: Critical condition
Action: Depending on piston ring condition unit should be overhauled and liner dressed-up or re-honed. If piston rings are in spotless condition, the unit can be kept in operation



Condition: Scuffing marks on liner
Acceptance: Critical condition
Action: Unit to be overhauled. Local scoring and scuffing marks are to be dressed up or re-honed

6.3 Action required

6.3.2 Liner

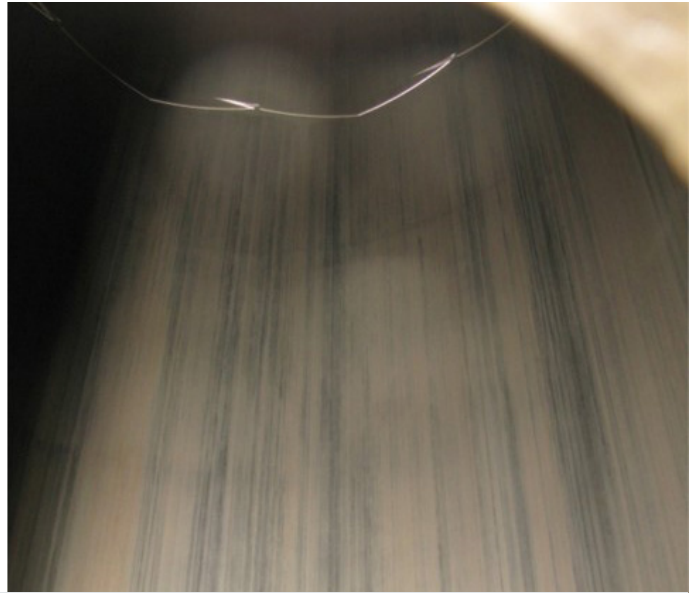
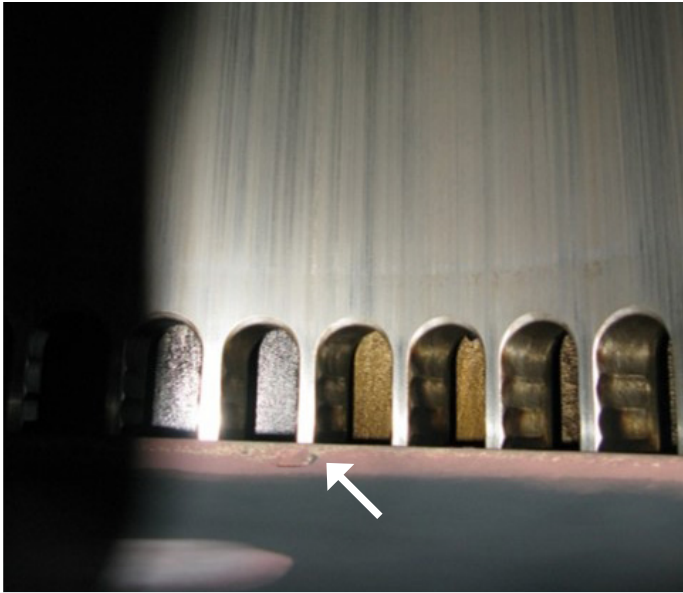

- Condition:** Totally scuffed unit with dull appearance. Note the reddish spots on the piston crown top, which are oxidised iron from the liner
- Acceptance:** Critical condition
- Action:** Such a liner has to be replaced as soon as possible

Other indications to identify a scuffed liner (adhesive wear):

- Wear profile with greatest wear at measuring point C or mostly D, see also chapter 5.2
- Visual appearance of liner seems to be visually in homogenous condition, but microstructure of such a liner is destroyed
- Wear steps on running surface, in range of lubricating oil grooves or around scavenging air ports
- Sharp burrs on scavenging air ports

Adhesive wear (scuffing) results in a destroyed microstructure of the cast iron (thermo mechanical transformation layer), which is unfavourable for safe piston-running. If only the piston rings are replaced the piston running behaviour will be unstable and unit may fail again. Such a liner is to be replaced even if the wear limit has not yet been reached.

Visual examples, see next page

6.4 How to identify a scuffed liner

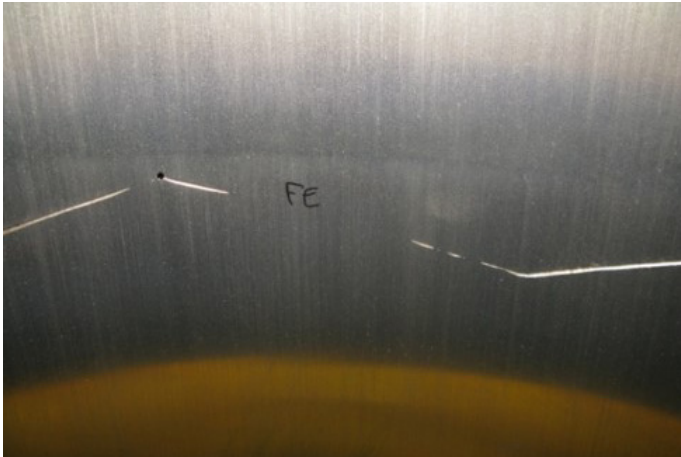

Condition: Totally scuffed liner surface and liner grooves partly worn down



Condition: Scuffed liner with wear step in the region of the liner grooves



Condition: Scuffed liner with wear step in the region of the scavenging ports



Condition: Scuffed liner with burrs on the edges of the scavenging air ports

6.5 Possible actions for locally scuffed liners (temporary measures)

Possible action if a locally scuffed liner cannot be replaced (temporary measures)

- Lubricating groove re-grinding
- Remove sharp edges and burrs from scavenge air ports by grinding
- Remove wear ridge at TDC (top dead centre) by grinding
- Remove wear steps on running surface over whole stroke
- Local scoring and scuffing marks are to be dressed up

Dressing-up local scoring and scuffing marks

1. Material required

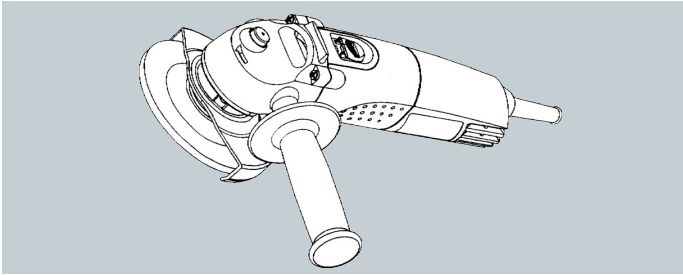

Angle grinder (100 mm or 180 mm diameter)

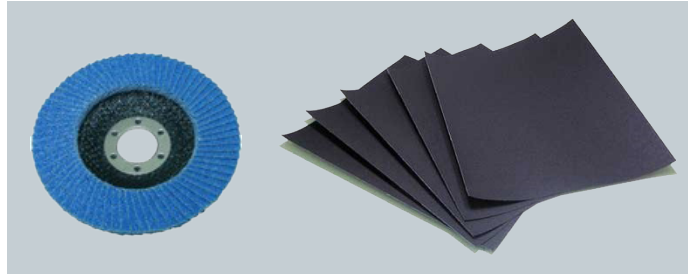

Serrated grinding disk and emery cloth (grain size 80 - 120)

2. Examples of local scoring and scuffing marks



3. Dressing-up procedure

If the piston is installed, cover the top of the piston with rags to avoid ingress of dirt between liner, piston and piston rings.

For such kind of scoring marks it is not the intention to remove them complete as this might result in a liner shape that is too uneven and causes blow by, but to break the surface of such scored liner structure.

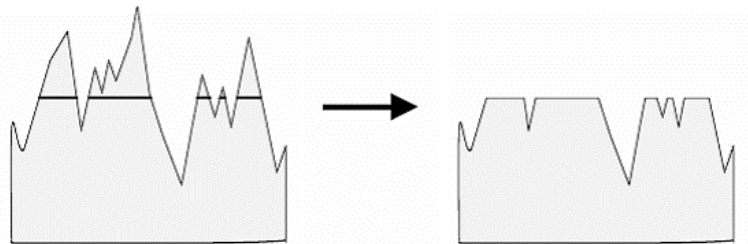

Scored surface before dressing up

Liner surface after dressing up

4. Example of dressed liner surface



6.6 Pre-requisites for a cylinder liner before it can be re-honed

This requirements are valid for all cylinder liners of cast iron.

The cylinder liner must fulfil the following criteria:

- No cracks
- Honing is not recommended if the liner wear is eccentric and more than 1 mm out of centre. This can be difficult to measure, but one method is to compare the thickness of the wear edges around the liner.

Bore diameter [mm]	350 – 580	600 – 760	820 – 960
Measuring Points B – F Original \varnothing + [mm]	0.80 – 1.40	1.50 – 1.90	2.20 – 2.50
Measuring Points G – K (L) Original \varnothing + [mm]	0.40 – 0.60	0.60 – 0.80	0.90 – 1.00

- O-ring grooves must be in good condition

NOTE: Liners which exceed the above mentioned diameter limits have to be scrapped!

6.7 Requirements for a cylinder liner after honing

A finish honed cylinder liner must fulfil following criteria before being accepted as properly reconditioned and therefore fit for further service:

Bore diameter [mm]	350 – 580	600 – 760	840 – 960
Measuring Points B – F Original \varnothing + [mm]	1.20 – 1.80	1.80 – 2.40	2.70 – 3.00
Measuring Points G – K (L) Original \varnothing + [mm]	0.60 – 0.90	0.90 – 1.20	1.35 – 1.50

- The difference of the liner diameter should, over a length of 200 mm, not vary more than shown in the table below.

Bore diameter [mm]	380 – 580	600 – 760	840 – 960
\varnothing difference / 200 [mm]	0.25	0.40	0.50

NOTE:

- Cylinder liners that have reached approximately 40% of the maximum admissible cylinder liner wear, according to the Maintenance Manual and/or
- Re-honed cylinder liners depending on the liner wear profile

7 Piston crown condition

Top of piston crown is to be checked visually for oil or water leakage

The top of piston land is to be checked with tool template 94366a to estimate the loss of material. Wear limits please refer to MM 3403-4.

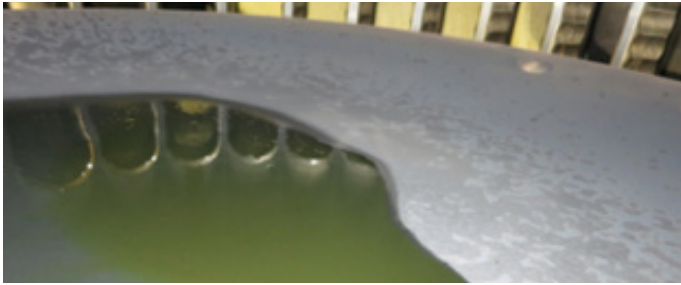

Condition: Oil on top of piston, leaking from valve shaft (rod joint ring)
Acceptance: Critical condition
Action: Source of oil leak to be found and rectified

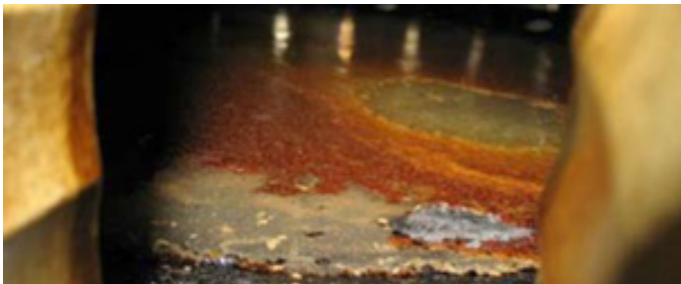

Condition: Water on top of piston leaking from a cracked valve seat, liner or cover
Acceptance: Critical condition
Action: Source of water leak to be found and rectified

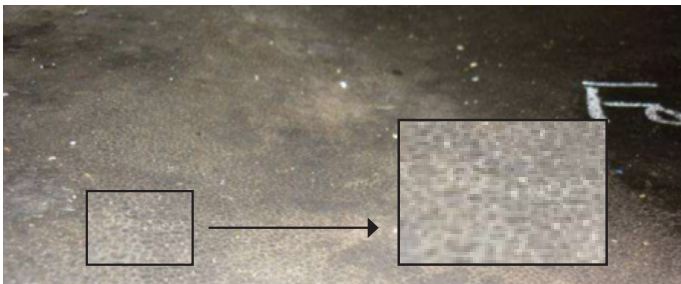

Condition: Loss of material, so-called 'paving stone' or 'elephant skin' appearance, indicating high-temperature corrosion
Acceptance: Acceptable
Action: Wear to be checked and recorded (Template 94366)



Condition: Excessive loss of material, above wear limit. See arrow, clearance between template 94366 and piston
Acceptance: Critical condition
Action: Piston to be replaced



Condition: Piston cooling oil leakage caused by defective o-ring in piston crown
Acceptance: Critical condition
Action: Source of oil leak to be found and rectified



Condition: Carbon deposits on piston crown
Acceptance: Critical condition
Action: Piston underside drain oil analysis highly recommended. Consider to reduce feed rate or switch to a lower BN cylinder oil if not yet in use.

8 Sample pictures for a visual inspection report

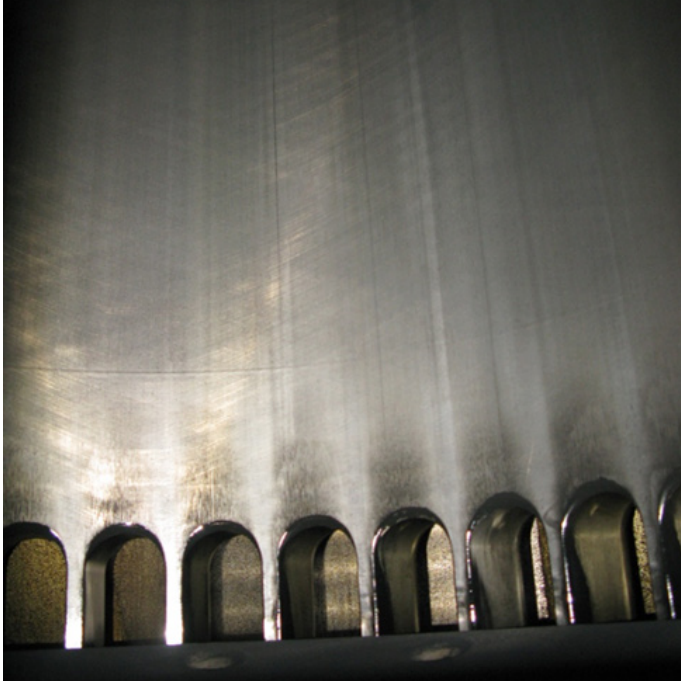

Condition of piston crown top and liner surface above scavenging air port

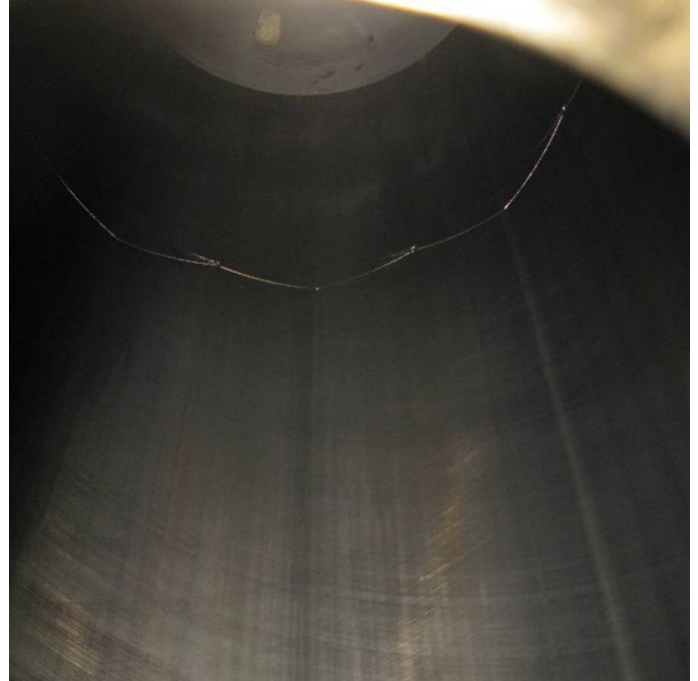

Liner surface as high as possible

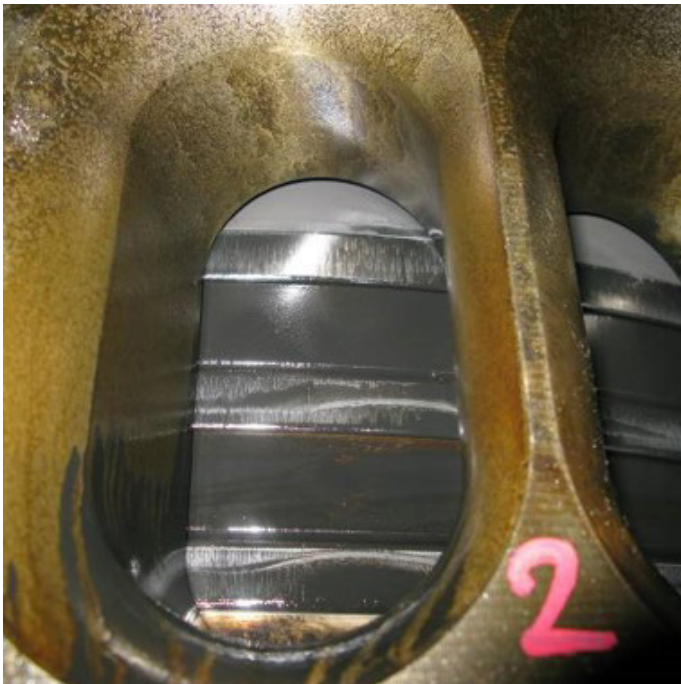

Uncleaned piston ring package



Clean the ring package and mark the piston rings



A ring



Take picture of each piston ring, in case some abnormalities are noticed also take picture of these spots



A ring gap



B ring



C ring



D ring



Carbon deposit



Carbon deposit

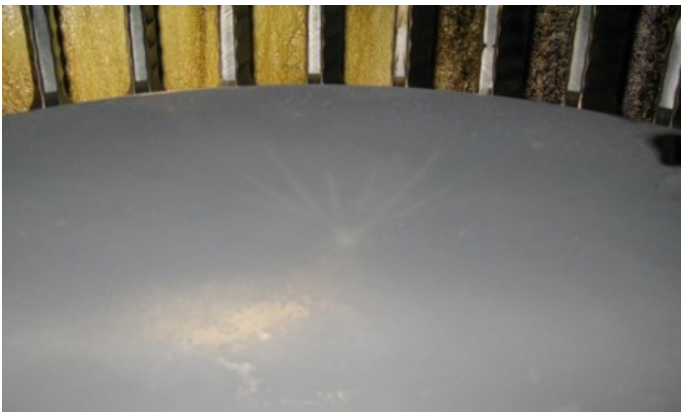

Piston top land



Piston skirt



Take picture of piston underside

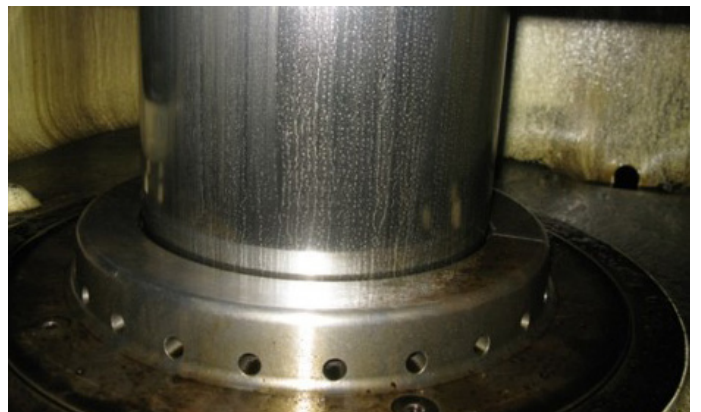

Piston rod



Piston underside space



Space after water separator

9 Template example for regular measurements visual inspection report

WINGD
Winterthur Gas & Diesel

Field Testing

Installation: **MV X** Engine: **6RT-flex82T** Lic: **HYU** Hull no: **X** Nom. power: **23'900 kW** Nom. rev: **75 rpm** Insp: **1**

Unit 3, BN100 SLOC setting 1.15 [g/kWh]	Running hours [hrs]	Coating	Coating thickness [µm]	Wear [mm/1'000hrs]	Groove clearance [mm]	Condition
Ring A	5'588	CC	0.341		0.42	
Ring B	5'588	CC	0.180		0.40	
Ring C	5'588	CC	0.190		0.40	
Liner	26'834					
Piston head	5'588					
Skirt	26'834					
Fuel injectors						

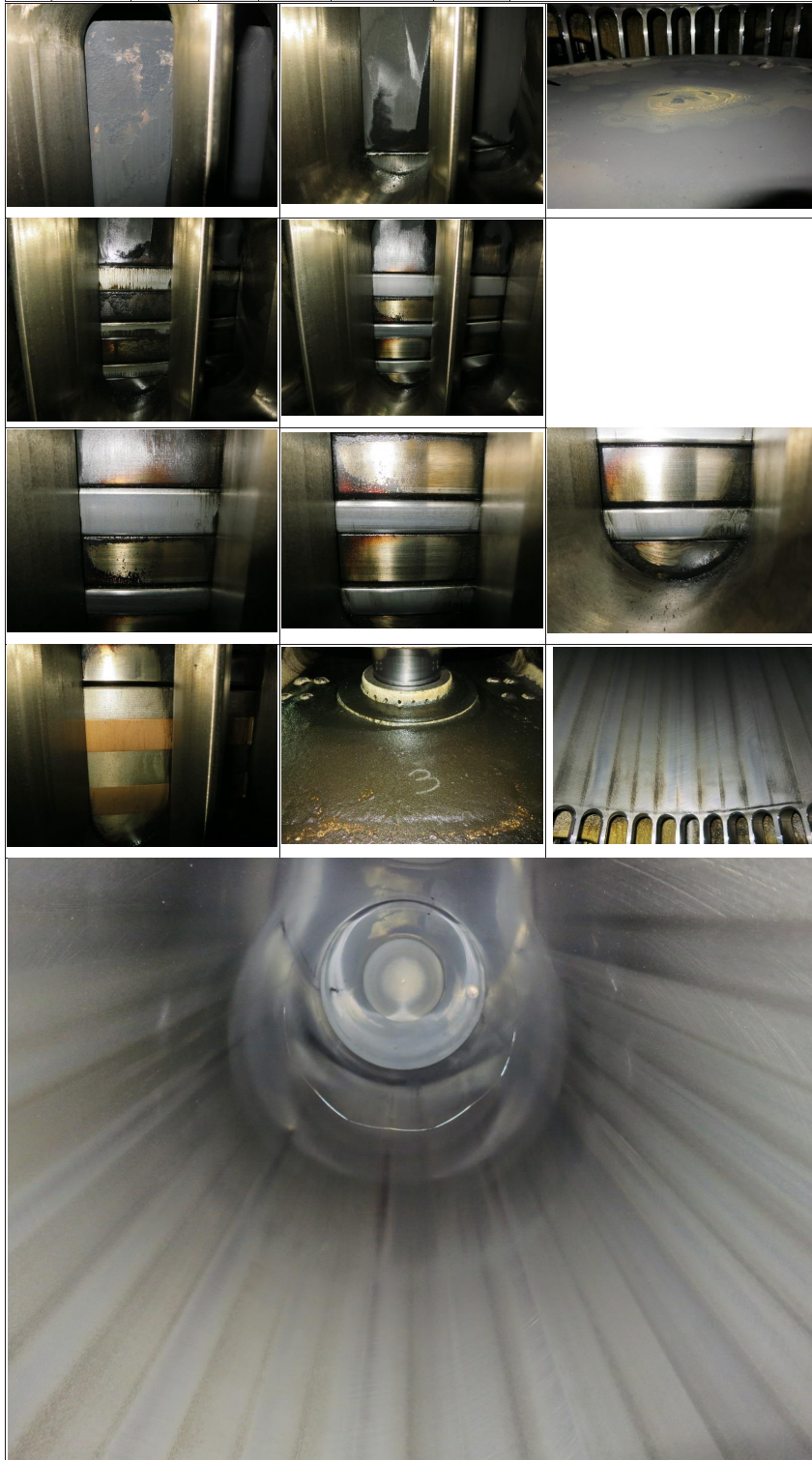

10 Selection of the cylinder oil

The selection of the correct BN of the cylinder lubrication oil must be driven by the results from piston underside drain oil analysis. However, as a general guidance for suitable combinations, the following figure shows starting points for the optimization process and recommendations if piston underside drain oil monitoring is not done.

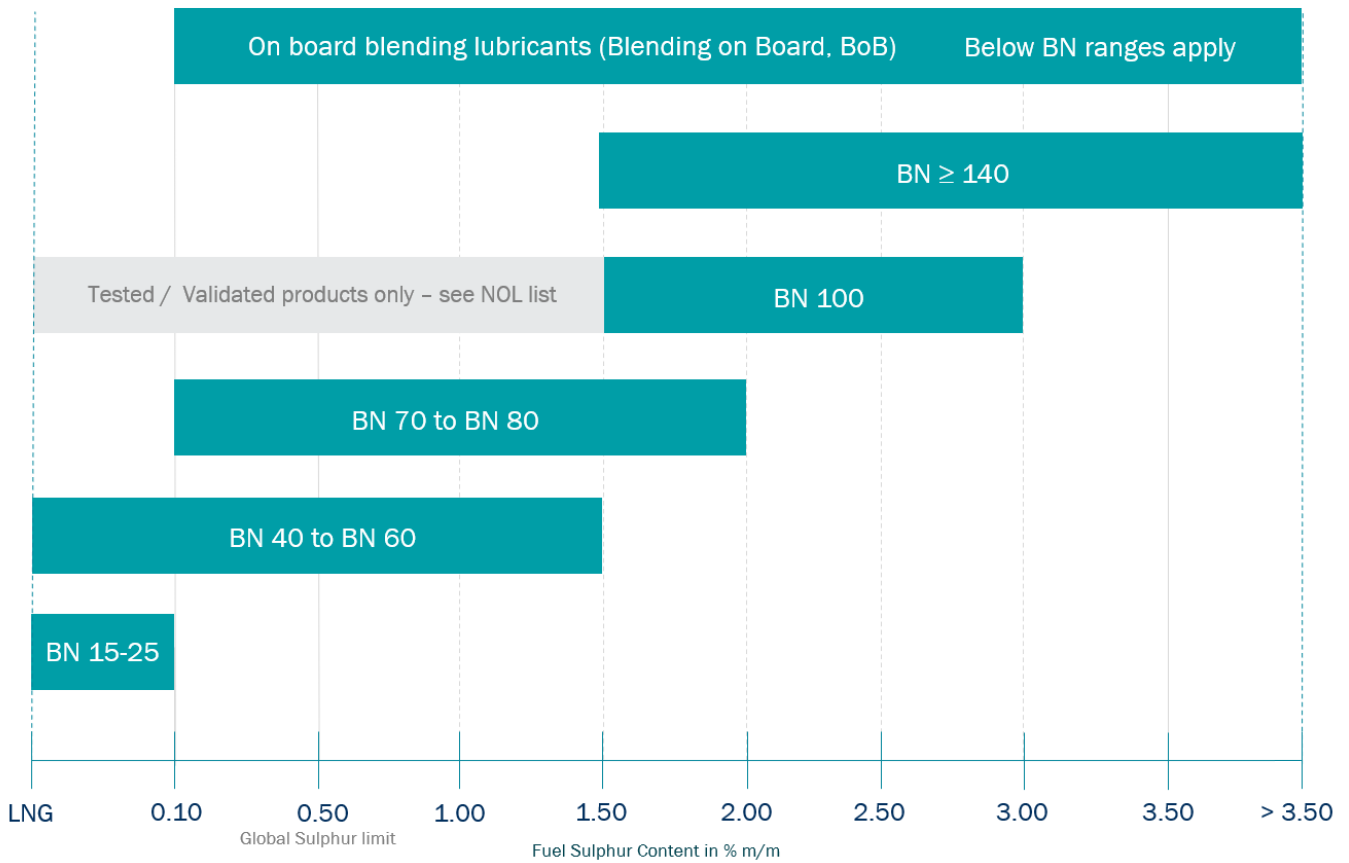

11 Cylinder oil sampling

NOTE: The oil sampling should be done under any of these conditions:

- Minimum once a week
- After a fuel change
- After an oil change
- After a feed rate change.

NOTE: This procedure must be done only if the engine is in stable operation for a minimum of 12 hours on a known fuel with the same cylinder oil feed rate, engine load and other variable factors.

1. Flushing.

1.1 Close the ball valve (002) for approximately 30 minutes to 60 minutes.

NOTE: Some parts can look different depending of the engine.

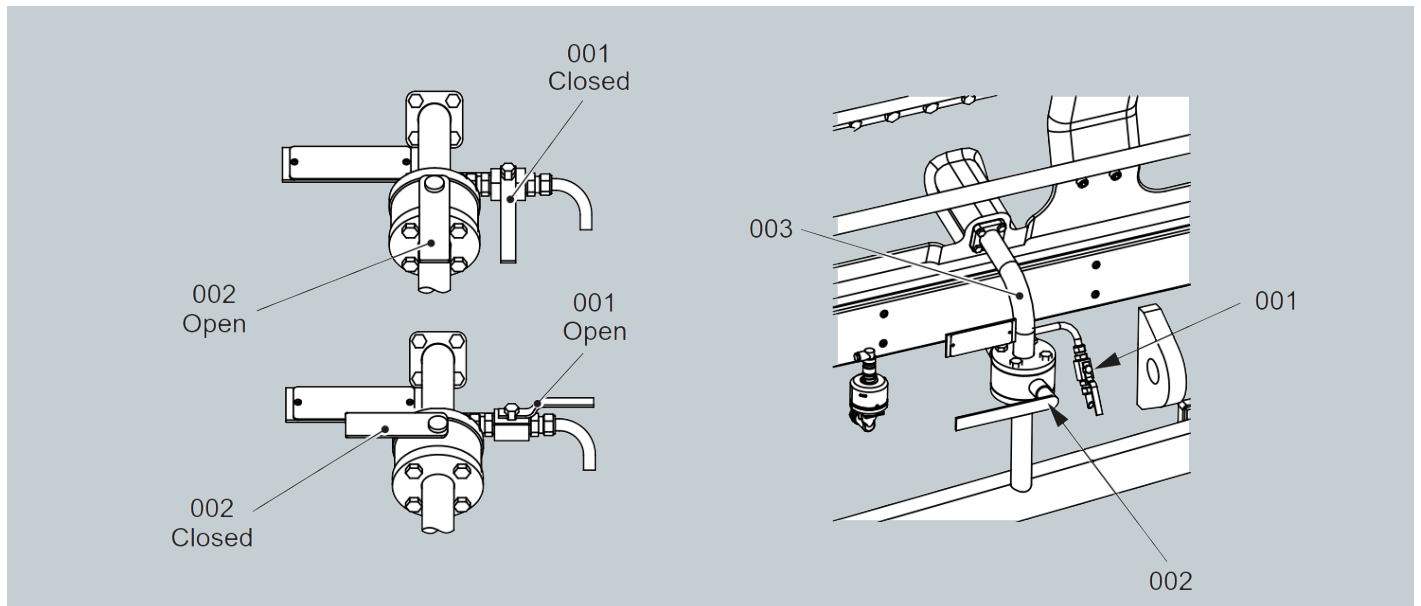

- 1.2** Put an applicable container under the oil sample valve (001).
1.3 Slowly open the oil sample valve (001) to flush out oil and possible dirt.
1.4 Close the oil sample valve (001).
1.5 Open the ball valve (002) to drain the remaining oil from the dirty oil pipe (003).
1.6 Close the ball valve (002).

2. Sampling

- 2.1** Make sure that the label on the sample bottle refers to the related cylinder.
2.2 Wait approximately 10 minutes to 60 minutes.
2.3 Put the sample bottle under the sample valve (001) and slowly open it. Fill the sample bottle
2.4 Close the oil sample valve (001).
2.5 Open the ball valve (002) to drain the oil in the dirty oil pipe (003).

3. Do Step 1 and Step 2 again for each cylinder.

4. Write the applicable data on the oil analysis form (eg operation conditions, fuel parameters, cylinder oil feed rate etc.).

5. Do an on-board analysis of the samples. The analysis must include the data that follows:

- Residual BN
- Iron (Fe) content (if possible)

6. Send the oil samples to a laboratory for analysis.

7. Compare the results from the laboratory with the on-board results.

12 Piston underside drain oil analysis interpretation

1. Cylinder oils up to BN 25

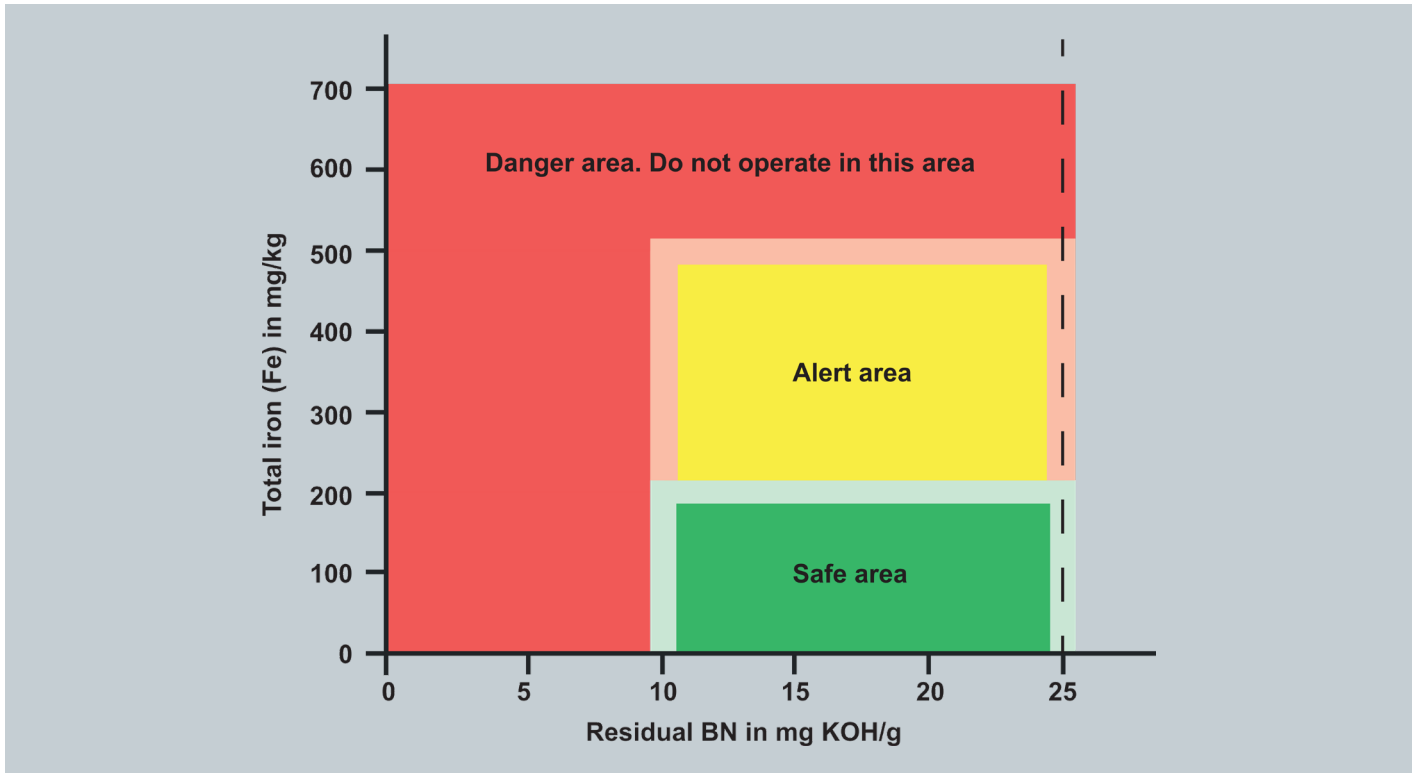

2. Cylinder oils with BN 40 or higher

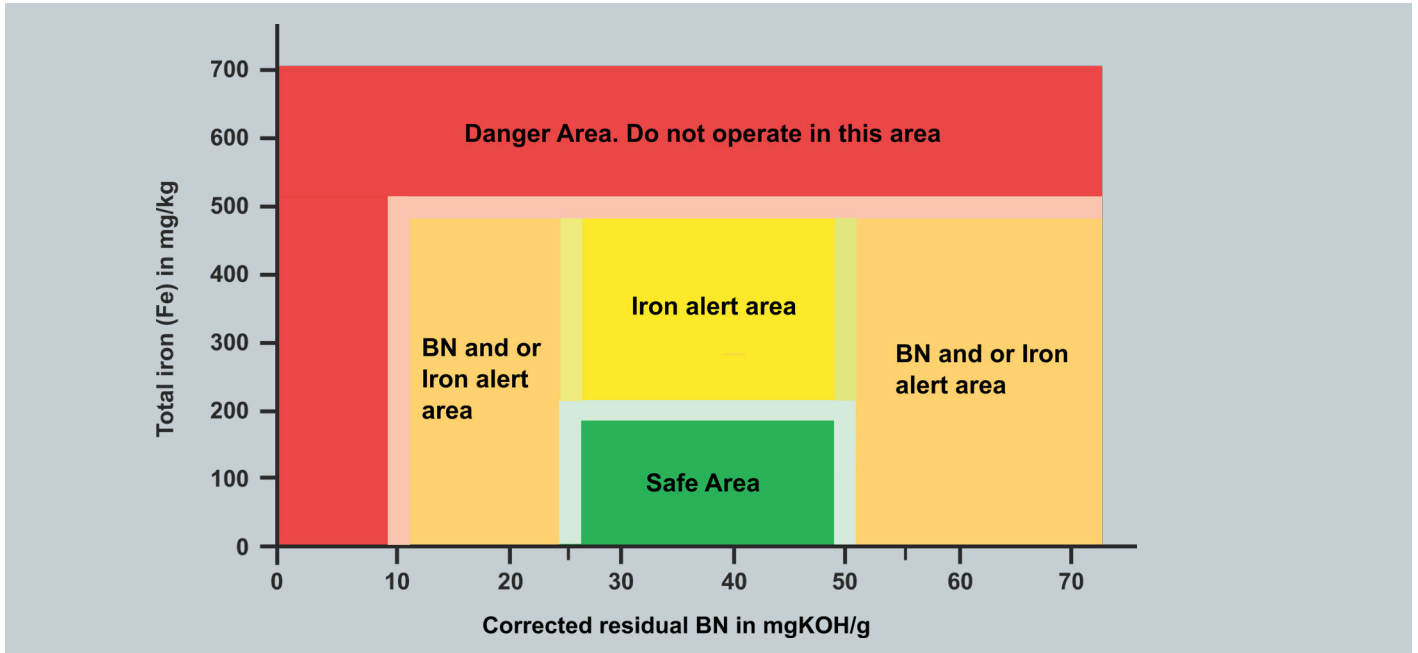

13 Feed rate optimization

During the engine screening and for regular analysis, adjust the parameters of the cylinder lubrication as follows:

1. Compare the results with the figures in chapter 12 as required and do the following:

- If the results show operation in the safe area, keep the feed rate or optimize the operation by decreasing the feed rate in small steps of 0.05g/kWh.
- If the results show operation in one of the alert areas, keep the feed rate and do as follows:
 - Do regular checks of the piston ring and the cylinder liner conditions through scavenge ports.
 - Alternatively, the feed rate can be increased/decreased to get the results in the safe area
- If the results show operation in the danger area, increase the feed rate or use a cylinder oil with a higher BN.

2. Continue with piston underside drain oil analysis monitoring.

Note: There is a spreadsheet tool available to fill in the piston underside drain oil analysis data. The tool will help to structure the data. Additionally, the tool evaluates the data and gives recommendations accordingly.

To download the piston underside drain oil analysis tool, go to the Winterthur Gas & Diesel webpage www.wingd.com, search for "Tribology" and go to page "Tribology Fuels & Lubricants".

Piston underside drain oil analysis tool (screenshot)

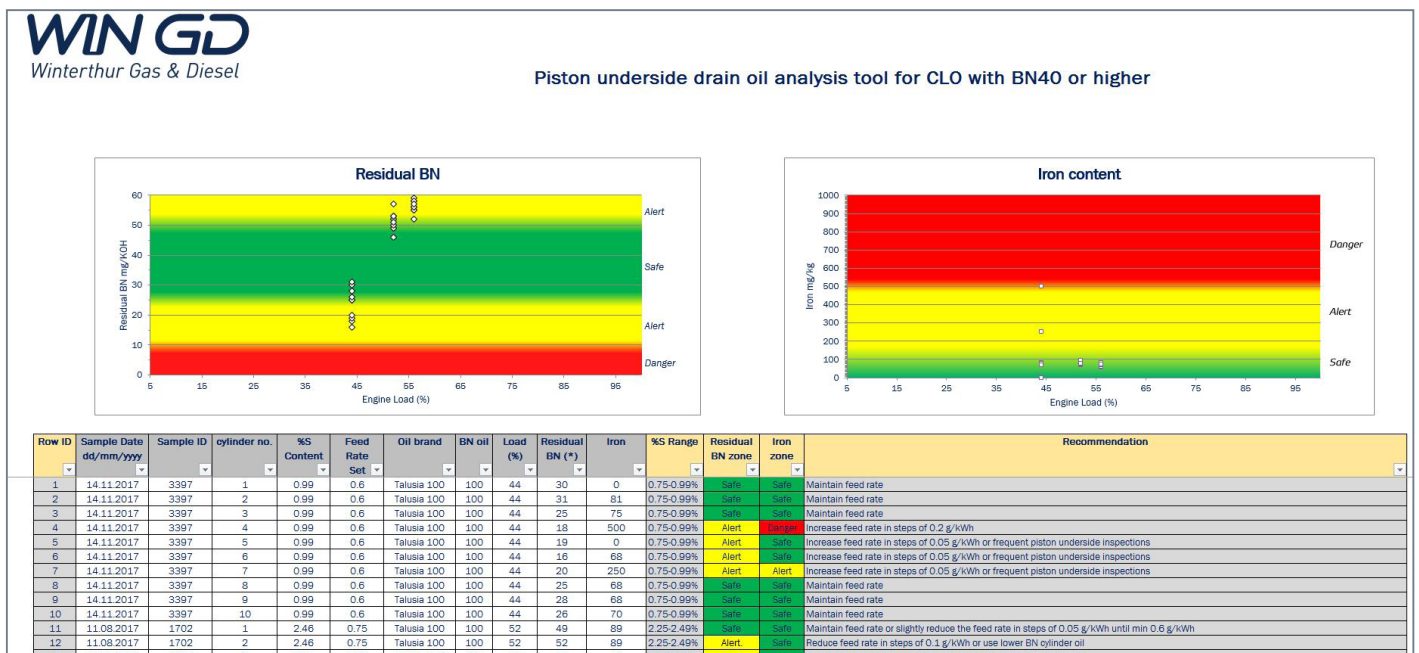

14 Running-in of new components

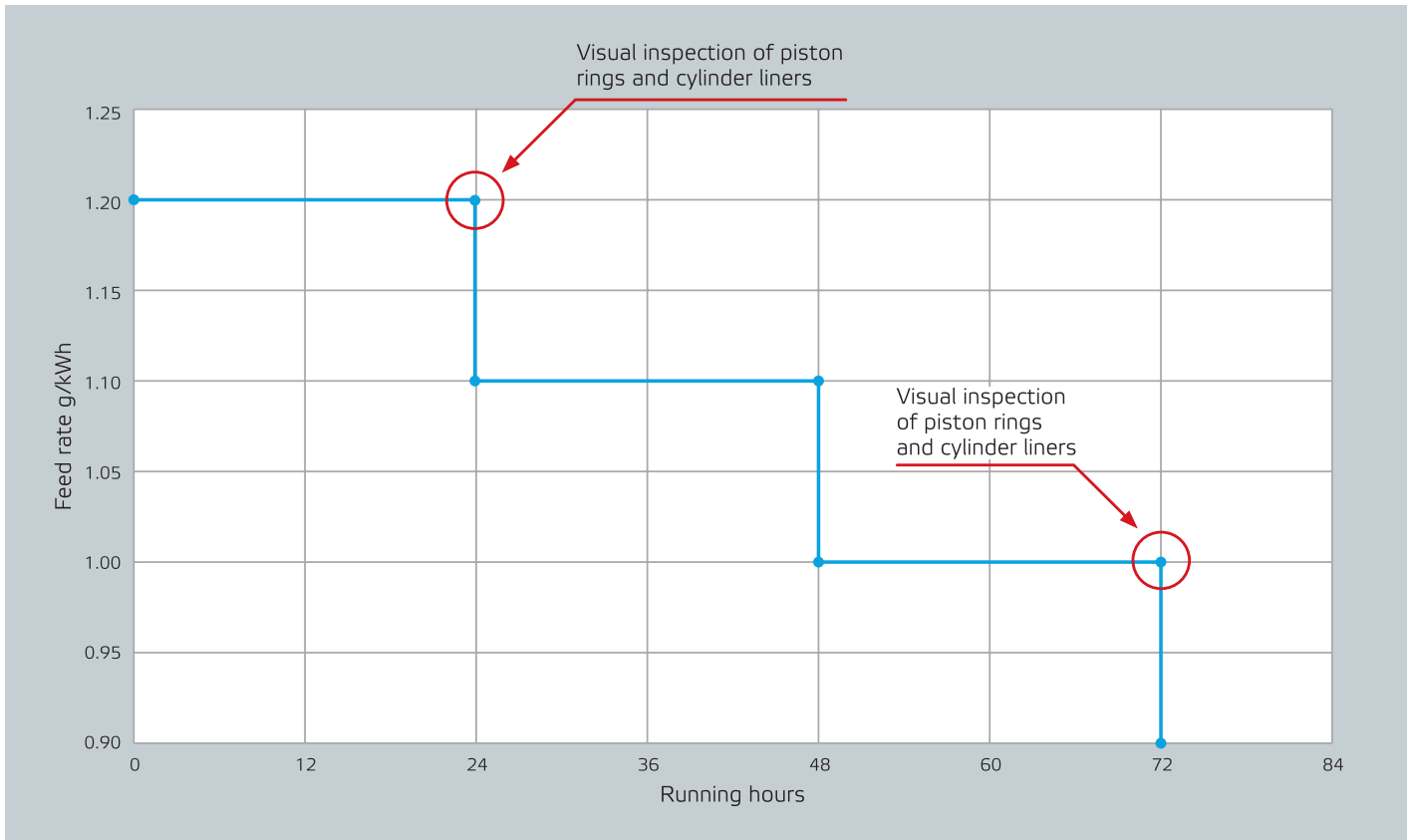

NOTE: Do not reduce feed rate if the BN and/or iron level are out of safe or alert area. See page 31.

NOTE: After 72 hours, the feed rate can be set to normal settings.

ATTENTION: This procedure is valid for engines equipped with full chrome ceramic ring pack and plateau honed liners. WinGD recommends to follow the running-in procedure described in the Operation Manual for engines equipped with older ring and liner executions

15 List of piston-running relevant WinGD technical documents

Technical bulletins & tools:

Go to www.wingd.com/en/technology-innovation/engine-technology/engine-design/tribology-fuels-lubricants to download the following documents:

- Lubricants for WinGD engines
- Validated Engine Oils for WinGD engines
- WinGD Piston Underside Drain Oil Analysis Tool
- Diesel Fuels for WinGD engines
- WinGD_TIN011 IMO 2020 Operation Guideline
- WinGD Guide for judging condition of relevant piston-running components

Engine Manuals:

Go to www.wingd.com/en/engines, select your engine type and go to "Operation & Maintenance" to download the following documents:

- Maintenance Manual
- Operation Manual

17 Contacts

How to contact Winterthur Gas & Diesel Ltd

For questions about the content of this Guideline please contact your nearest official service representative for WinGD engines.

Further contact possibilities can be accessed through www.wingd.com

Winterthur Gas & Diesel Ltd.

P.O. Box 414
Schützenstrasse 3
CH-8401 Winterthur
Tel. +41 52 264 8844
Fax +41 52 264 8866
E-mail: info@wingd.com

© 2021 Winterthur Gas & Diesel Ltd. – All rights reserved

No part of this publication may be reproduced or copied in any form or by any means (electronic, mechanical, graphic, photocopying, recording, taping or other information retrieval systems) without the prior written permission of the copyright holder. Winterthur Gas & Diesel Ltd. makes no representation, warranty (express or implied) in this publication and assumes no responsibility for the correctness, errors or omissions for information contained herein. Information in this publication is subject to change without notice.

Unless otherwise expressly set forth, no recommendation contained in this document or any of its appendices is to be construed as provided due to a defect in the engine, but merely as an improvement of the engine and/or the maintenance procedures relating thereto. Any actions by the owner/operator as a result of the recommendations are not covered under any warranty provided by Winterthur Gas & Diesel Ltd and such actions will thus be at the owners/operators own cost and expense.

NO LIABILITY WHETHER DIRECT, INDIRECT, SPECIAL, INCIDENTAL OR CONSEQUENTIAL, IS ASSUMED WITH RESPECT TO THE INFORMATION CONTAINED HEREIN.

THIS PUBLICATION IS CONFIDENTIAL AND INTENDED FOR INFORMATION PURPOSES ONLY.

Winterthur Gas & Diesel Ltd. (WinGD) is a leading developer of two-stroke low-speed gas and diesel engines used for propulsion power in merchant shipping.

WinGD sets the industry standard for reliability, efficiency and environmental sustainability. WinGD provides designs, training and technical support to engine manufacturers, shipbuilders and ship operators worldwide.

WinGD is headquartered in Winterthur, Switzerland, where, as one of the earliest developers of diesel technology, it started the design of large internal combustion engines in 1893 under the "Sulzer" name.

WinGD® is a registered trademark.

© Copyright, 2021 Winterthur Gas & Diesel Ltd.

www.wingd.com

WIN GD